

## DS-TCG227-A, DS-TCG227-AIR ANPR Camera



### Entrance & Exit Product

2MP

CMOS

ANPR

IR

VF

Relays

All-in-one

PowerZoom

DS-TCG227 camera series, based on deep learning, consists of protective cover, lens, camera, LED and power supply, offers high-definition Progressive Scan CMOS, and integrates intelligent recognition algorithms for specific applications such as entrance management, road safety enforcement, in-vehicle monitoring, parking lot control, etc.

### Key Features

- 1/2.8" Progressive Scan CMOS
- Up to 1920 × 1200 resolution with real-time video
- 2x pics high-performance IR LEDs (Valid for IR camera models)
- 3.1 to 9mm motorized vari-focal lens
- Support relay output to control vehicle barrier
- Support loop triggering or video triggering
- Support multi-frame LPR
- Support dirty license plate recognition
- Support quick pass of multiple vehicles
- Support vehicle type, vehicle color and vehicle brand recognition
- Integrated shield, lights, TF Card (up to 128 G)
- Up to 30,000 whitelists
- Offline control
- PoE (802.3af)
- One-touch focus
- Manual capture and ANPR

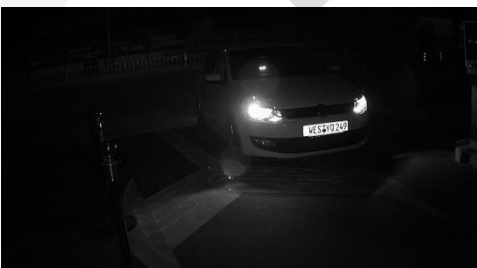

Multi-Frame LPR

Features and Functions



Multi-frame LPR

VS



LPR only one frame

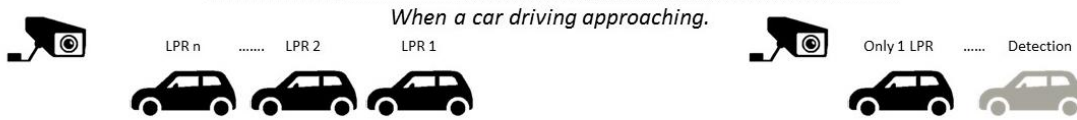

Comparison to guarantee best result

- High Accuracy



Quick Pass of Multiple Cars



Free-flow

VS



Stop & Go, one by one



time-consuming

- More efficient and Lower the risk of car damage



## Specification

<b>Camera</b>	Image Sensor	1/2.8" Progressive Scan CMOS
	Min. Illumination	Color: 0.002Lux@(F1.2, AGC ON) B/W: 0.002Lux@(F1.2, AGC ON)
	Shutter Speed	1/30 s to 1/100,000 s
	Lens	3.1 mm to 9 mm
	IR Cut Filter	Support
<b>Compression Standard</b>	Video Compression	H.265, H.264
	Vieo Bit Rate	32 Kbps to 16 Mbps
<b>Image</b>	Image Format	JPEG
	Max. Resolution	1920 × 1200
	Frame Rate	25 fps(1920 × 1200)
	Image Settings	Saturation: 0 to 100 Brightness: 0 to 100 Contrast: 0 to 100 Gain: 0 to 100 3D DNR: Off, Normal and Expert modes are selectable. White balance: White Balance 1 and White Balance 2 are selectable.
<b>Snapshot</b>	Picture Format	JPEG with configurable quality
	Analytic	Support ANPR
	LED Control	Support automatic light control/time control of LEDs
<b>Network</b>	Storage	TF
	Protocols	TCP/IP, HTTP, DHCP, DNS, RTP, RTSP, NTP, FTP Upload Pictures
	Security	User Authentication, Heartbeat, NTP
	API	ISAPI, SDK
<b>Interfaces</b>	Communication Interface	1 RJ45 10M/100M/1000M Ethernet port
	Serial Port	1 RS-485 Port, 1 RS-232 Port
	Built-in LED	2 built-in LEDs
	Audio Output	1-ch audio output
	Triggered Input	3-ch triggered input, including 1-ch I/O triggered input and 2-ch alarm input
	Relay Output	2-ch relay output, support open/close of barrier gates
	Memory Card Slot	1 TF card slot, up to 128GB
<b>General</b>	Working Temperature	-30°C to 70°C (-22°F to 158°F)
	Working Humidity	90% or less (non-condensing)
	Power Supply	12 VDC, PoE (802.3af)
	Power Consumption and Current	12 VDC, 1.0 A, 20 W
	Protection Level	IP67, IK10
<b>Vehicle Recognition</b>	Vehicle Type	Car (including SUV, MPV, Pickup)/truck/bus/van
	Vehicle Color	Red, yellow(including orange), green, blue, purple, brown, white, grey(including silvery), black

Vehicle Brand	Hyundai, Toyota, Kia, Honda, Volkswagen, Benz, Nissan, Ford, ISUZU, BMW, Chevrolet, Mitsubishi, Renault, Opel, Suzuki, Skoda, Daewoo, Audi, Mazda, Hino, Peugeot, Ssang Yong, Citroen, Fiat, Scania, MAN, Volvo, Lexus, Seat, Land Rover, Daihatsu, UD Trucks, Subaru, IVECO, MINI, Jeep, Porsche, Chery, Dodge, Chrysler, Acura, Alfa Romeo, Great Wall, Infiniti, Smart, SAIC Maxus, JAC, Jaguar, GMC, Lincoln, JMC, SAAB, FAW, Yutong, Mercury, Joylong, Geely, Cadillac, Jinbei, Ankaï, Haima, Foton, King Long, Dongfeng, Emgrand
Country/Region supported by ANPR	<b>European and Russian-Speaking Regions:</b> Turkey, Croatia, Slovakia, Czech Republic, Bulgaria, Macedonia, Hungary, Greece, Poland, France, Netherlands, Switzerland, Spain, United Kingdom, Ireland, Germany, Italy, Austria, Israel, Ukraine, Kyrgyzstan, and Russian Federation
ANPR Recognition Accuracy (Under recommended installation and lighting conditions)	Capture rate > 98% Vehicle moving direction recognition accuracy > 96% Mistaken capture rate < 2% (entrance/exit), < 5% (checkpoint) <b>European and Russian-Speaking Regions:</b> LPR accuracy > 98% Country/Region recognition accuracy > 98%

## Dimensions

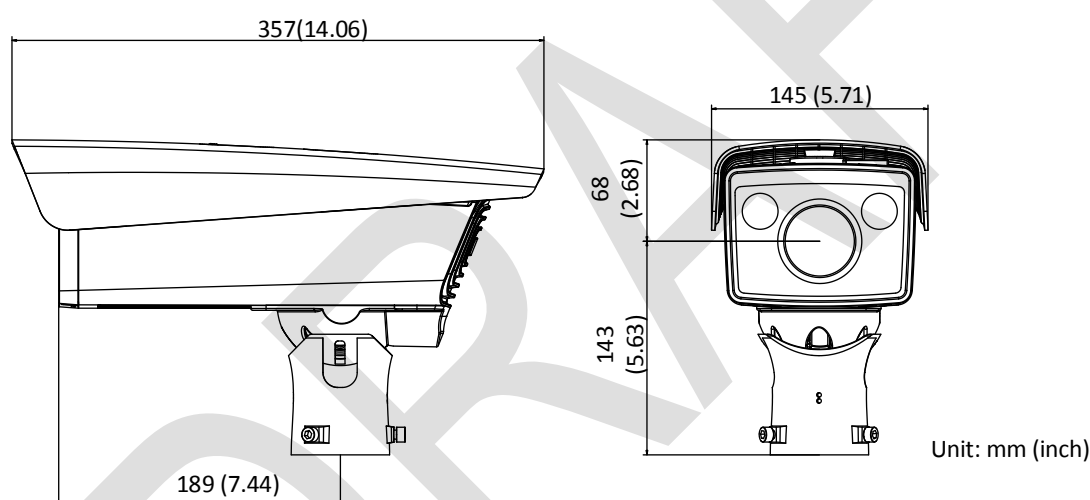









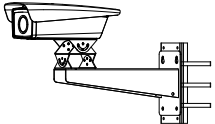

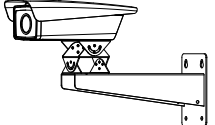
## Available Models

White Light Supported: DS-TCG227-A, 305001269

IR Supported: DS-TCG227-AIR, 305001217

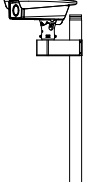
## Accessories

	DS-1275ZJ/HWB	307500078	Combined with DS-1701ZJ/HWB	
	DS-1701ZJ/HWB	307500079	Combined with DS-1275ZJ/HWB	
		190501359	Wall Mount	
	L2500-X1300-R117(TCG225)	315100004	Pole Mount	
	L1300-R117(TCG225)	315100004	Pole Mount	
		315400006	Pedant Mount	

Distributed by



## HIKVISION®

### Headquarters

No.555 Qianmo Road, Binjiang District,  
Hangzhou 310051, China  
T +86-571-8807-5998  
overseasbusiness@hikvision.com

**Hikvision USA**  
T +1-909-895-0400  
sales.usa@hikvision.com

**Hikvision Italy**  
T +39-0438-6902  
info.it@hikvision.com

**Hikvision Singapore**  
T +65-6684-4718  
sg@hikvision.com

**Hikvision Africa**  
T +27 (0) 0351172  
sale.africa@hikvision.com

**Hikvision Europe**  
T +31-23-55-42-770  
info.eu@hikvision.com

**Hikvision France**  
T +33(0)1-85-330-450  
info.fr@hikvision.com

**Hikvision Oceania**  
T +61-2-8599-4233  
salesau@hikvision.com

**Hikvision Hong Kong**  
T +852-2151-1761

**Hikvision Middle East**  
T +971-4-8816086  
salesme@hikvision.com

**Hikvision Spain**  
T +34-91-737-16-55  
info.es@hikvision.com

**Hikvision Canada**  
T +1-909-895-0400  
sales.usa@hikvision.com

**Hikvision Russia**  
T +7-495-669-67-99  
saleru@hikvision.com

**Hikvision Poland**  
T +48-22-460-01-50  
poland@hikvision.com

**Hikvision Korea**  
T +82-31-731-8841  
sales.korea@hikvision.com

**Hikvision India**  
T +91-22-28469900  
sales@pramahikvision.com

**Hikvision UK**  
T +01628-902140  
support.uk@hikvision.com

**Hikvision Brazil**  
T +55 11 3318-0050  
Latam.support@hikvision.com